

REZKAR ZA MINIATURNI SPOJ

KONSTRUKCIJA:

Število rezkarjev, ki jih lahko sestavljamo, določimo po razpredelnici, glede na debeline lesa.

UPORABA:

Za dolžinsko in širinsko spajanje mehkega in trdega lesa. V strešnih konstrukcijah, v stavbnem pohištvu, v izdelavi podov, letvic in plošč. Uporaba na strojih za vzdolžno spajanje, strojih za čepljenje, miznih rezkarjih in posebnih strojih.

FINGER JOINTING CUTTER

DESIGN:

Single cutters to be combined as shown on the drawing, and determined according to the table of wood thickness. Each cutter with tips parallel to axis.

APPLICATION:

For cutting mini-finger joints in soft and hard wood, in roof constructions, for building components, flooring and lath production. Used on longitudinal joining machines, bench milling machines and special machines.

MINIZINKENFRÄSER

AUSFÜHRUNG:

Mit achsparallelen Schneiden, geradling hinterschliffen Profilzähne versetzt schneidend.

ANWENDUNG:

Stirnseitiges Fräsen von Zinkenprofilen für Langverleimungen in Vollhölzern für hochbeanspruchte Bauteile im Holzbau. Einsatz auf Maschinen für Längsverbindungen, Zapfen-Fräsmaschinen, Tischfräser und Spezialmaschinen.

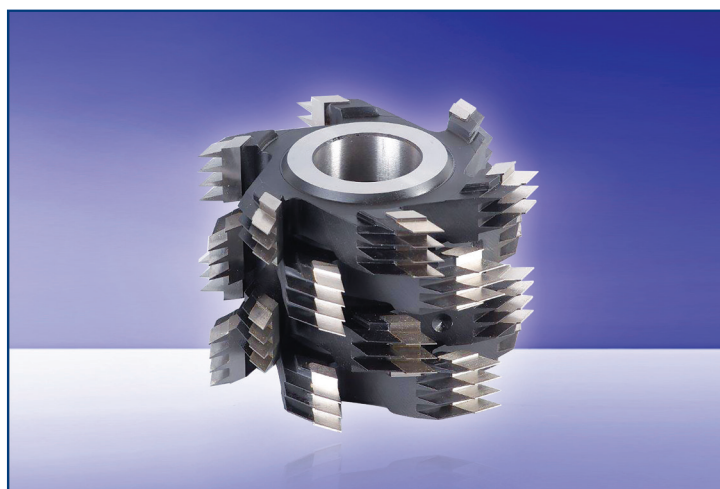

Art.No.	D mm	B mm	d min	l	t	Z	ZZ	n max
6662107	160	28,6	50	L10/10	3,8	2+2	3+4	8000
6694069	160	28,6	50	L10/11	3,8	2+2	3+4	8000
6694624	160	28,6	50	L10/11	3,8	3+3	3+4	8000
6682087	170	28,6	50	L15/15	3,8	2+3	3+4	8000
6671362	170	28,6	50	15/16,5	3,8	2+2	3+4	8000
6695434	180	33	50	L20/20	6,2	2+2	2+3	8000
6652699	180	33	50	L20/22	6,2	2+2	2+3	8000
6662113	250	28,6	50	L10/10	3,8	3+3	3+4	6000
6685525	250	28,6	50	L10/11	3,8	3+3	3+4	6000
6694591	260	28,6	50	15/15	3,8	3+3	3+4	6000
6694234	260	28,6	50	15/16,5	3,8	3+3	3+4	6000
6662116	260	33	50	20/20	6,2	3+3	2+3	6000
6695506	260	33	50	20/22	6,2	3+3	2+3	6000

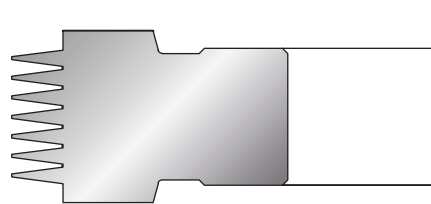
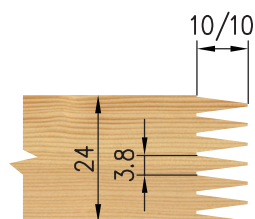
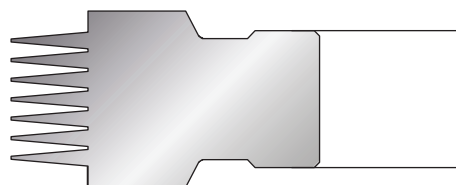
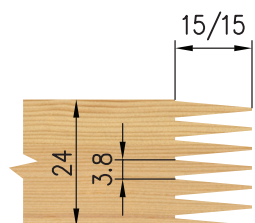
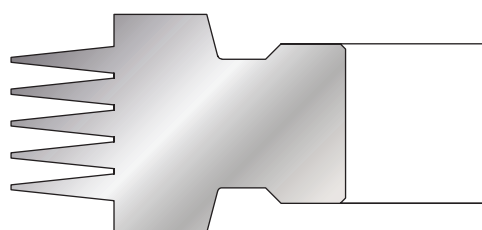
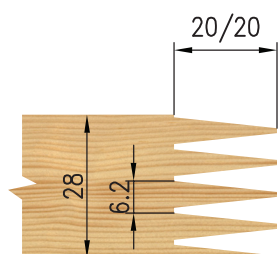
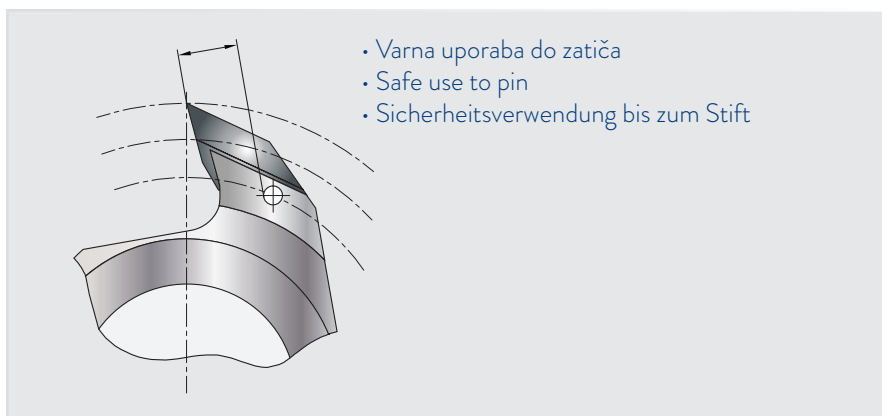

Število rezkarjev Number of cutters Anzahl der Fräser	t 3,8; I10/10, I10/11, I15/15, I15/16,5		t 6,2; I20/20, I20/22	
	Debelina lesa Wood thickness Holzdicke	Širina rezkarjev Cutting width Fräserbreite	Debelina lesa Wood thickness Holzdicke	Širina rezkarjev Cutting width Fräserbreite
1	24	28,6	28	33,0
2	51	55,2	59	65,0
3	77	81,8	90	96,0
4	104	108,4	121	127,0
5	131	135,0	152	158,0
6	157	161,6	183	199,0
7	184	188,2	214	220,0
8	210	214,8	245	251,0
9	237	241,4	276	282,0
10	264	268,0	307	313,0